

BRITZ[®]



Model: BRITZ 9398

- Current Rating : 13A
- Standard : BS1363A
: SS145/A
: MS589/A
- Voltage Rating : 250V
- Material : Polycarbonate (Unbreakable)
- Colour : White



Model: BRITZ 9398L

- Current Rating : 13A
- Standard : BS1363A
: SS145/A
: MS589/A
- Voltage Rating : 250V
- Material : Polycarbonate (Unbreakable)
- Colour : White
- LED Neon



Model: BRITZ 9515

- Current Rating : 15A
- Standard : BS546
: SS472
: MS1577
- Voltage Rating : 250V
- Material : Polycarbonate (Unbreakable)
- Colour : White



BRITZ®



Model: TP-711

- Product Spec : 3-5mm X140mm
- Voltage Rating : 100v-500v
- Colour : Clear Plastic
- Smart Neon Indicator With Tag



Model: TP-712

- Product Spec : 4.0mm X 205mm
- Voltage Rating : 100v-500v
- Colour : Clear Plastic
- Smart Neon Indicator With Tag



Model: TP-713

- Product Spec : 3.5mm X160mm
- Voltage Rating : 100v-500v
- Colour : RED
- Smart Neon 2 Way Crossover Design

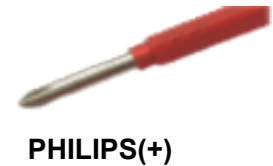

BRITZ®

Model: BR-MK107

Description

The LED mosquito killer can be used in bedrooms, living hall, office or any indoor place that require killing of mosquitos and flying insects. The energy saving LED light is designed for prolonged usage without the need to replace any tube. It is safe for children and mothers to use the mosquito killer.

Specification:

- Input : AC110-250V
- Cable Length : 1M
- Coverage Area : 25M2
- Power : 6W Energy Saving
- Rated Frequency : 50/60Hz
- Suitability : Safe for Pets & Children

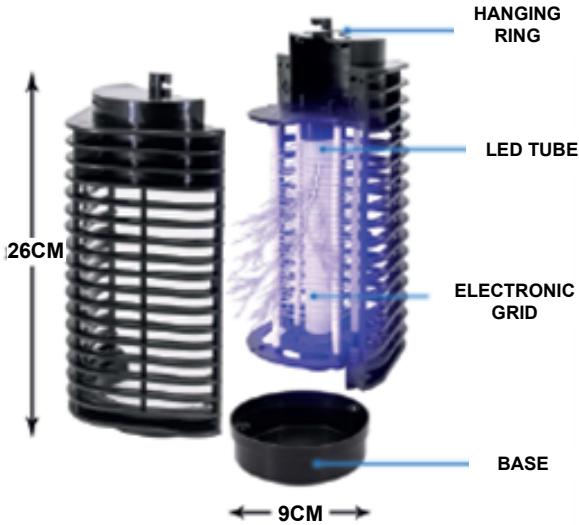

NO NEED TO REPLACE TUBE



LONG LASTING LED



STOPS DENGUE



BRITZ[®]

PVC Cover



BRITZ[®]

Connector



Fuse



BRITZ[®]

PVC Box

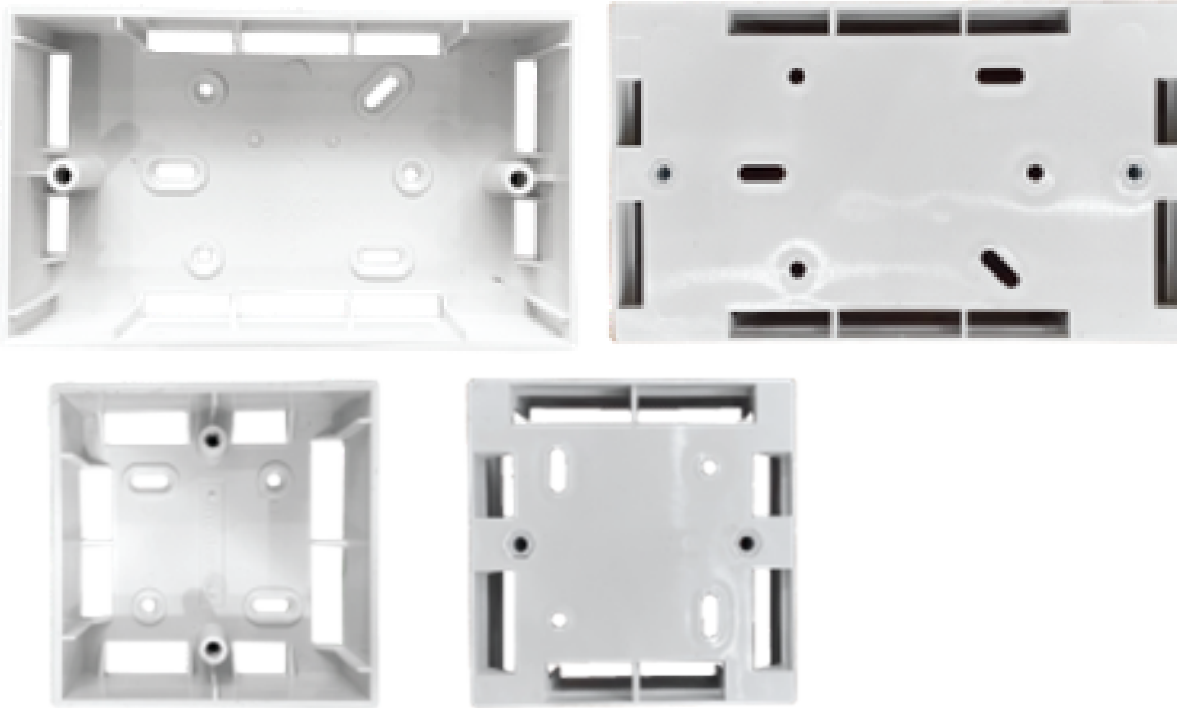

PVC Plate



BRITZ[®]

PVC Box

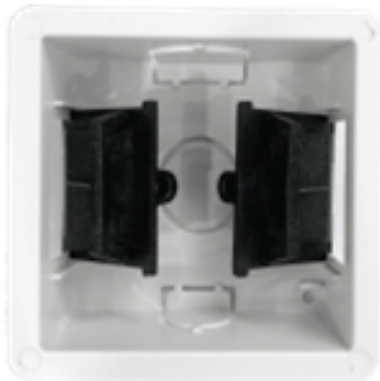

BRITZ®

Lamp Holder



BRITZ[®]

Power Cord



Cable Clip



BRITZ[®]

Description

- 24 Hour Mechanical Timer - With 15 minute segments
- Simple to Use - Simply press down the segments when you want your device to turn on
- Ideal for Indoor Power Applications - Great for slow cookers, lighting, fish tanks and more
- Manual Override Function - Override the timer to power the connected device

Operation Instruction

- Turn the disc clockwise until the arrow is pointing to the current time.
- Push the slice down according to your desired work time. Each slice corresponds to 15 minutes.
- Push switch down to \ominus for timer function. Simply push up to ON for constant power and override timer function.
- Plug in timer and connect your device to the timer.

Model: BR-TM-01 / BR-TM-02U



Dimension (mm)

Model	H(mm)	L(mm)	W(mm)
BR-TM-01	74	74	55
BR-TM-02U	74	74	55

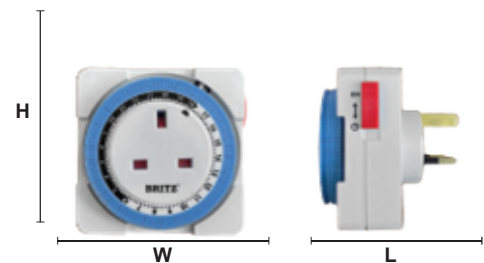

BRITZ[®]

Model: BR-MCE113A

BRITZ 13A 1GANG SWITCH SOCKET OUTLET METAL-CLAD

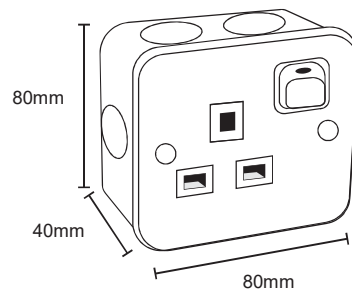

- Voltage Rating : 250V AC
- Current Rating : 13A socket
- Nominal plate size : 80 x 80mm
- Minimum wall box depth : 40mm
- IP Rating : IP4X
- Pack (carton / box) : 50pcs

Model: BR-MCE213A

BRITZ 13A 1GANG SWITCH SOCKET OUTLET METAL-CLAD

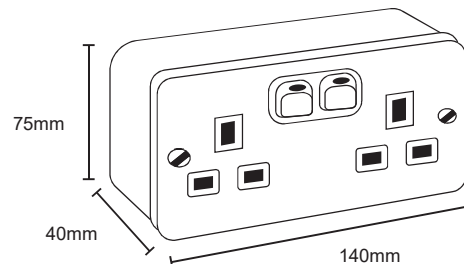

- Voltage Rating : 250V AC
- Current Rating : 13A per socket
- Nominal plate size : 140 x 75mm
- Minimum wall box depth : 40mm
- IP Rating : IP4X
- Pack (carton / box) : 30pcs

BRITZ[®]



Model: BR-558L

Description

- AC Input Power : 250V
- Frequency Range : 50Hz
- Rated Current : 13AMAX
- Approved Standard : SS246 MS589 BS5733
: SASO2203 BS 1363
(Singapore Approved Standard)
- Power : 3250 WATTS MAX
- Fused Protection : 13A
- Neon Light : Yes
- 2-Pin Friendly : Yes



Direct 2-PIN Plug in

BRITZ[®]



Model: BR-221U

Description

- AC Input Power : 230V- 250V
- USB Output Power : DC 5V 21 00mA
- Frequency Range : 50/60Hz
- Rated Current : 13AMAX
- Approved Standard : SS246
(Singapore Approved Standard)
- Power : 3250 WATTS MAX



2USB Outlet



Direct 2-PIN Plug in

BRITZ[®]



Model: BR-928

Description

- AC Input Power : 230V- 250V
- Frequency Range : 50/60Hz
- Rated Current : 13AMAX
- Approved Standard : SS246
(Singapore Approved Standard)
- Power : 3250 WATTS MAX



Direct 2-PIN Plug in

BRITZ[®]



Model: BR-928

Description

- AC Input Power : 230V- 250V
- Frequency Range : 50/60Hz
- Rated Current : 13AMAX
- Approved Standard : SS246
- Power : (Singapore Approved Standard)
- LED Neon : 3250 WATTS MAX



Direct 2-PIN Plug in

DT[®] ENGLAND



Model: DT-10

Description

- AC Input Power : 230V- 250V
- Frequency Range : 50/60Hz
- Rated Current : 13AMAX
- Approved Standard : SS246
(Singapore Approved Standard)
- Power : 3250 MAX



COLOURED
SWITCHES



SMART
INDICATOR



2-PIN
FRIENDLY



FIRE
RETARDANT



SAFETY
SHUTTER



3 X 13A
OUTLET



OVERLOAD
PROTECTION



Direct 2-PIN Plug in

BRITZ[®]



Model: TR-5

U.S.A, Canda, Japan,
Taiwan, Philippines,
China



Model: TR-6

U.S.A, Canada, Japan,
Taiwan, Philippines,
China, Thailand



Model: TR-7

Singapore, Malaysia,
Hong Kong, UK England,
Dubai



Model: TR-9

Korea, Indonesia,
France



Model: TR-9A

China, Thailand, Philippines,
Europe, South America, Chile,
Uruguay, Paraguay



Model: TR-9B

China, Thailand,
Philippines, Europe,
South America, Chile



Model: TR-9C

Denmark, Spain, Portugal,
Belgium, Finland, Netherland,
Norway, Sweden, Italy



Model: TR-10

England, South Africa



Model: TR-16

China, Australia,
New Zealand



Model: TR-17

China, Australia,
New Zealand



Model: MWT-6(6020)
 U.S.A, Canda, Japan,
 Taiwan, Philippines, China,
 Thailand



Model: MWT-7(6040)
 Singapore, Malaysia,
 Hong Kong, UK England,
 Dubai

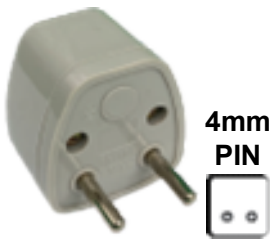

Model: MWT-9A(6030)
 China, Thailand, Philippines,
 Europe, South America, Chile,
 Uruguay, Paraguay

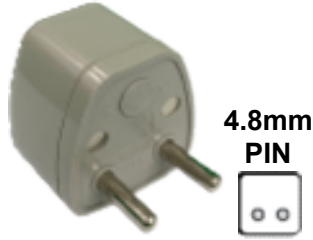

Model: MWT-9B(6030)
 China, Thailand,
 Philippines, Europe,
 South America, Chile,
 Uruguay, Paraguay

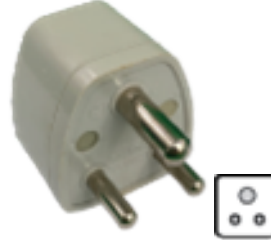

Model: MWT-10(6000)
 England, South Africa

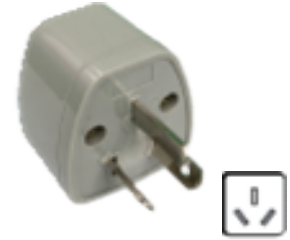

Model: MWT-16(6050)
 China, Australia, New
 Zealand



China, Australlia, New Zealand



Korea, Indonesia,
 France

BRITZ[®]

Model: RCD 08 (ELCB Adaptor)

Description

RCD08 10mA adaptor for added protection against the risk of electric shock. It instantly cuts the power in the event of an earth connection leakage. It is latching, therefore power needs not to be reset at each use and it is ideal for home appliance spike protection .



Active (Non-Latching) Type -

When power is cut to the device. The RCD will trip DO NO need to be RESET RCD Protection - Against the risk of fatal electric shocks

Adaptor - Simply plug in the tool or device you want to use
40ms Trip Speed - To provide fast protection

Operating instructions

STAGE 1 • Insert the RCD adaptor into a 13 amp mains socket and switch on.

STAGE 2 • Press the RESET button. The RED indicator should appear.

STAGE 3 • Press the TEST button. The RED indicator will disappear from the CLEAR window.

• **DO NOT USE IF THE RED INDICATOR REMAINS.**

STAGE 4 • Press the RESET button. The RCD has now been set for safe use provided the RED indicator shows in the CLEAR window.

Latching RCDs do trip during power cuts but they automatically reset once the power returns, so they are great for fridges, freezers Refrigeration, Frost watchers, Aquariums, Chargers

Technical Specification:

- Voltage Rating : AC240V 50Hz
- Current Rating : 13A
- Rated Tripping Current : 10mA
- Operating Speed : <40mS
- Environmental Protection : IP2x
- Type Tested to : BS 7071 - 1992
BS 1363 - 1984

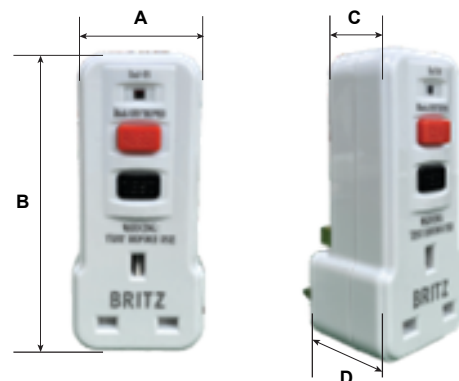

Dimension

A: 44MM
B: 110mm

C: 36MM
D: 39mm



BRITZ[®]

Model: RCD 11

Description

BRITZ Safety Model: RCD 11 10mA adaptor for added protection against the risk of electric shock. It instantly cuts the power in the event of an earth connection leakage. It is non-latching, therefore power needs to be reset at each use and it is ideal for home appliance spike protection.



Active (Non-Latching) Type -

When power is cut to the device, the RCD will trip and **NEED** to be RESET RCD Protection - Against the risk of fatal electric shocks

Adaptor - Simply plug in the tool or device you want to use
40ms Trip Speed - To provide fast protection

Operating instructions

STAGE 1 • Insert the RCD adaptor into a 13 amp mains socket and switch on.

STAGE 2 • Press the RESET button. The RED indicator should appear.

STAGE 3 • Press the TEST button. The RED indicator will disappear from the CLEAR window.

• **DO NOT USE IF THE ORANGE INDICATOR REMAINS.**

STAGE 4 • Press the RESET button. The RCD has now been set for safe use provided the RED indicator shows in the CLEAR window.

Technical Specification:

• Voltage Rating	: AC240V 50Hz
• Current Rating	: 13A
• Rated Tripping Current	: 10mA
• Operating Speed	: <40ms
• Environmental Protection	: IP2x
• Type Tested to	: BS 7071 - 1992 BS 1363 - 1984

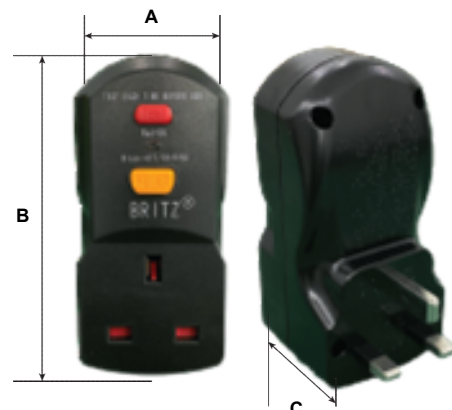

Dimension

A: 50MM B: 105MM C: 44.7MM



BRITZ[®]

Model: RCD 12

Description

RCD 12 10mA plug for added protection against the risk of electric shock. It instantly cuts the power in the event of an earth connection leakage. It is non-latching, therefore power needs to be reset at each use and it is ideal for home appliance spike protection.



Active (Non-Latching) Type -

When power is cut to the device, the RCD will trip and have to be RESET
RCD Protection - against the risk of fatal electric shocks

Adaptor - simply plug in the tool or device you want to use
40ms Trip Speed - to provide fast protection

Operating instructions

STAGE 1 • Insert the RCD plug into a 13 amp mains socket and switch on.

STAGE 2 • Press the RESET button. The RED indicator should appear.

STAGE 3 • Press the TEST button. The RED indicator will disappear from the CLEAR window.

• **DO NOT USE IF THE RED INDICATOR REMAINS.**

STAGE 4 • Press the RESET button. The RCD has now been set for safe use provided the RED indicator shows in the CLEAR window.

Technical Specification:

- Voltage Rating : AC250V 50Hz
- Current Rating : 13A
- Rated Tripping Current : 10mA
- Operating Speed : <40ms
- Environmental Protection : IP55
- Type Tested to : BS 7071 - 1992

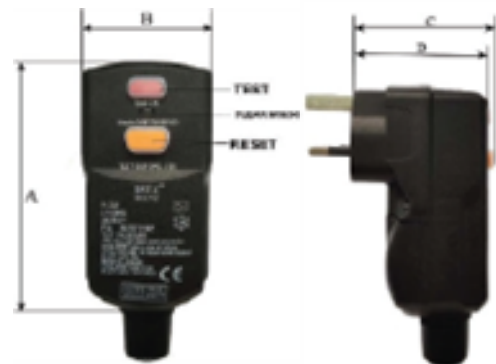

Dimension

A: 105MM
B: 50mm

C: 54MM
D: 51mm



BRITZ[®]

Model: BR-868U / 868UBK

Features

- Safety Shutter
- LED Power Indicator
- All-in-one adaptor
- Useable in over 150 countries : United Kingdom, Europe, Australia, New Zealand, Africa, Canada, India, Singapore, Malaysia and so on



SURGE PROTECTION

Specifications

- Electrical rating : 125V 6A, 250V 13A
- Size : 73*47*40mm
- Weight : 77g



2X 2.1A USB Charger



Dimension (mm)

Model	H(mm)	L(mm)	W(mm)
BR-868U	74	47	37
BR-868UBK	74	47	37

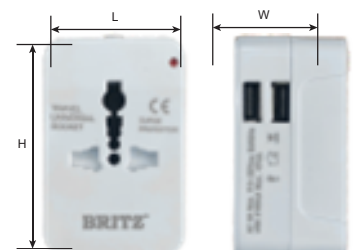

BRITZ[®]

Model: BR-838 / 838BK

Features

- Safety Shutter
- LED Power Indicator
- All-in-one adaptor
- Useable in over 150 countries : United Kingdom, Europe, Australia, New Zealand, Africa, Canada, India, Singapore, Malaysia and so on

Specifications

- Electrical rating : 125V 6A, 250V 13A
- Size : 73*47*40mm
- Weight : 77g



**SURGE
PROTECTION**



Dimension (mm)

Model	H(mm)	L(mm)	W(mm)
BR-838	74	47	37
BR-838BK	74	47	37

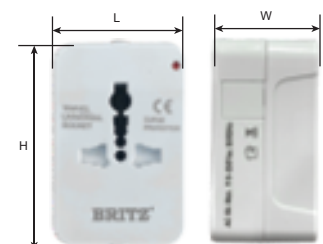

BRITZ[®]



Model: BR-232C

Description

- AC Input Power : 230V - 250V
- USB Output Power : DC 5V 2100mA
- Frequency Range : 50/60Hz
- Rated Current : 13A MAX
- Approved Standard : SS246
(Singapore Approved Standard)
- Power : 3250 WATTS MAX

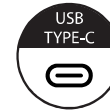

1USB & 1 Type-C Outlet



Direct 2-PIN Plug in

DC BRITZ®



Complies with
IMDA Standards
DA 102832



Model: K616DC

Description

- 32 Different Chimes
- Bright LED Flash Light
- Transmitter is IP44
- Anti-Interference System
- 150M Reachable Distance
- Receiver run on 3x AA Batteries



Battery

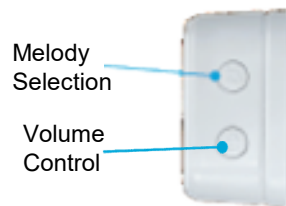

Features

- Transmitter is IP44 (Waterproof & Weatherproof)
- Strong anti-interference and jamming system to prevent false triggering and interference.
- Wireless transmitter is capable of reaching the receiver at up to 150m distance.
- Wireless Kinetic Transmitter is Battery-Free.
- LED indicator is energy efficient with low power consumption.
- Ideal for homes, offices, factories, hospitals and guest rooms in hotel etc. It can also be used for message notifying, alarms for the patients and elderly people.

Kinetic Bell Push

Receiver



Adhesive Tape

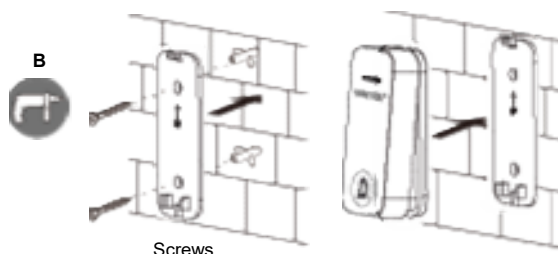

Screws

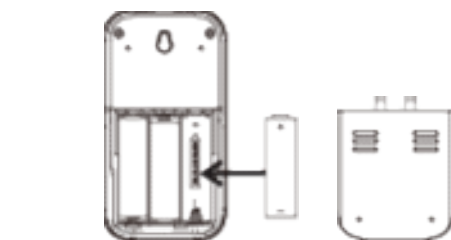
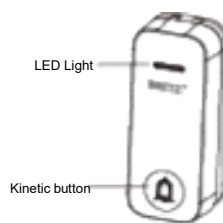

AC BRITZ[®]



Complies with
IMDA Standards
DA 102832



UK3-PIN



Melody Selection/
Pairing Button

Volume
Control



Model: K636AC

Description

- 32 Different Chimes
- Bright LED Flash Light
- Transmitter is IP44
- Anti-Interference System
- 150M Reachable Distance

Features

- Easy to install with screw or adhesive tape.
- Strong anti-interference and jamming system to prevent false triggering and interference.
- Wireless remote control reaches 150m at straight distance and up to 50m with any obstacles during the course transmission.
- LED indicator low power consumption.
- Ideal for homes, offices, factories, hospitals and guest room in hotel etc. It can also be used for message notifying, alarms for the patients and elderly people.

Kinetic Bell Push

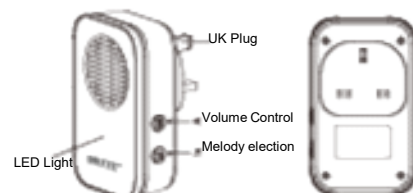
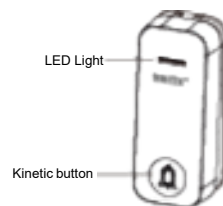
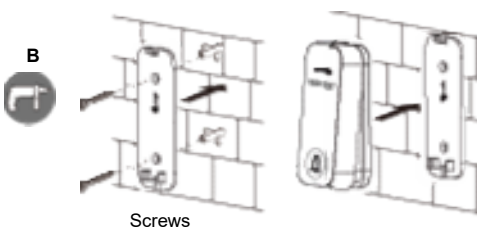

AC BRITZ®



Complies with
IMDA Standards
DA 102832



UK3-PIN



Melody Selection/
Pairing Button

Volume
Control

Model: K637AC

Description

- 52 Different Chimes
- Bright LED Flash Light
- Transmitter is IP44
- Anti-Interference System
- 200M Reachable Distance



Features

- Easy to install with adhesive tape.
- Strong anti-interference and jamming system to prevent false triggering and interference.
- Wireless remote control reaches up to 200m range.
- Kinetic transmitter (IP44) is waterproof and weatherproof.
- LED indicator consumes little power.
- Ideal for homes, offices, factories, hospitals and guest rooms in hotel etc. It can also be used for message notifying, alarms for the patients and elderly people.

Kinetic Bell Push



Adhesive Tape

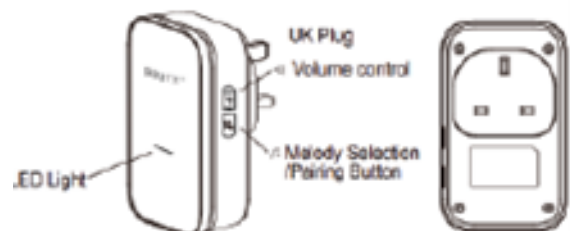
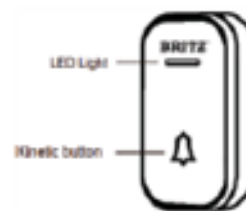

AC BRITZ®



Complies with
IMDA Standards
DA 102832



UK3-PIN



Melody Selection/
Pairing Button

Volume
Control

Model: K638AC

Description

- 52 Different Chimes
- Bright LED Flash Light
- Transmitter is IP44
- Anti-Interference System
- 200M Reachable Distance



Features

- Easy to install with adhesive tape.
- Strong anti-interference and jamming system to prevent false triggering and interference.
- Wireless remote control reaches up to 200m range.
- Kinetic transmitter (IP44) is waterproof and weatherproof.
- LED indicator consumes little power.
- Ideal for homes, offices, factories, hospitals and guest rooms in hotel etc. It can also be used for message notifying, alarms for the patients and elderly people.

Kinetic Bell Push



Adhesive Tape

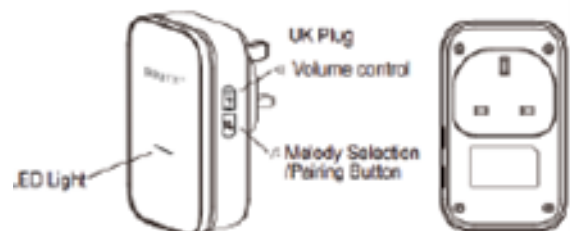
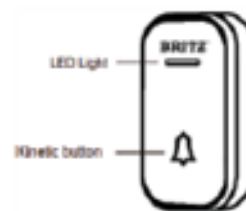

AC BRITZ®



Complies with
IMDA Standards
DA 102832



Contact-Lens



UK3-PIN



Volume Control

Melody Selection/
Pairing Button

Model: K639AC

Description

- 52 Different Chimes
- Bright LED Flash Light
- Transmitter is IP44
- Anti-Interference System
- 200M Reachable Distance



Features

- Easy to install with adhesive tape and screws (included).
- Strong anti-interference and jamming system to prevent false triggering and interference.
- Wireless remote control reaches up to 200m range.
- Kinetic transmitter (IP44) is waterproof and weatherproof.
- LED indicator consumes little power.
- Ideal for homes, offices, factories, hospitals and guest rooms in hotel etc. It can also be used for message notifying, alarms for the patients and elderly people.

How it works:

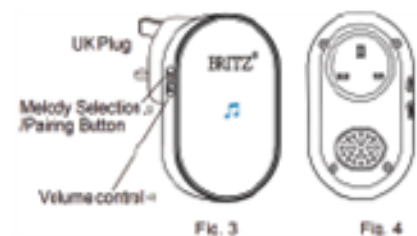
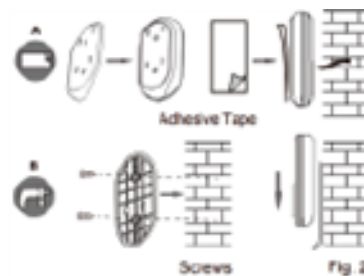
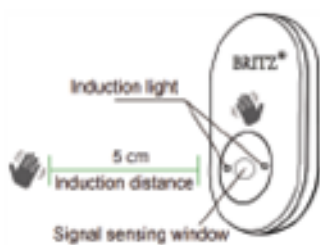

Transmitter unit (Weatherproof IP44):

BRITZ Contactless Transmitter is USB powered (Charging Cable Included). A single full charge of 2 hours allows for 4 to 6 months of usage.

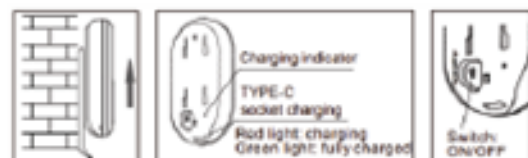

DC BRITZ®

Complies with
IMDA Standards
DA 102832



Model: 912DC

Description

- 25 Different Chimes
- Bright LED Flash Light
- Transmitter is IP44
- Anti-Interference System
- 150M Reachable Distance
- Run on 3x AA Batteries



Battery

Features

- Easy to install with screw or adhesive tape.
- Strong anti-interference and jamming system to prevent false triggering and interference.
- Wireless remote control reaches 1 00m at straight distance and up 50m with any obstacles during the course transmission.
- LED indicator low power consumption.
- Ideal for homes, offices, factories, hospitals, and guest room in hotel etc. It can also be used for message notifying, alarms for the patients and elderly people.

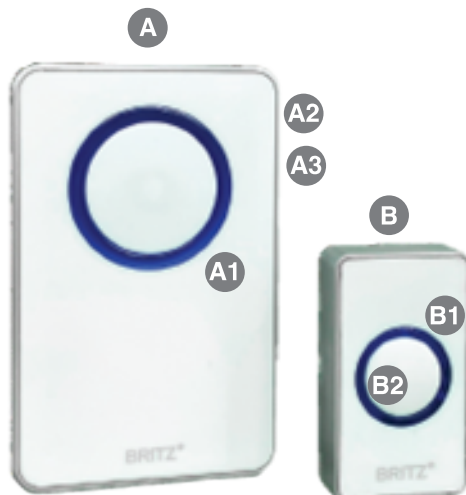

- Ⓐ Receiver
- Ⓐ1 LED flashing indicator
- Ⓐ2 Music selection button
- Ⓐ3 Volume selection button
- Ⓑ Transmitter
- Ⓑ1 LED indicator light
- Ⓑ2 Push button

AC BRITZ[®]

Complies with
IMDA Standards
DA 102832



Battery



UK 3-PIN

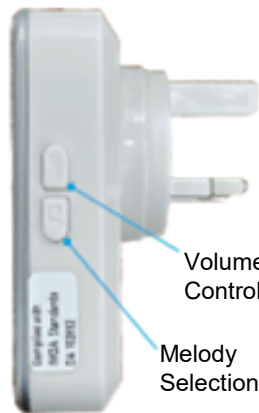

Volume
Control

Melody
Selection

Model: 665AC

Description

- 45 Different Chimes
- Bright LED Flash Light
- Transmitter is IP44
- Anti-Interference System
- 200M Reachable Distance



Features

- Strong anti-interference and jamming system to prevent false triggering and interference.
- Wireless remote control reaches up to 200m range.
- Kinetic transmitter (IP44) is waterproof and weatherproof.
- LED indicator consumes little power.
- Ideal for homes, offices, factories, hospitals and guest rooms in hotel etc. It can also be used for message notifying, alarms for the patients and elderly people.

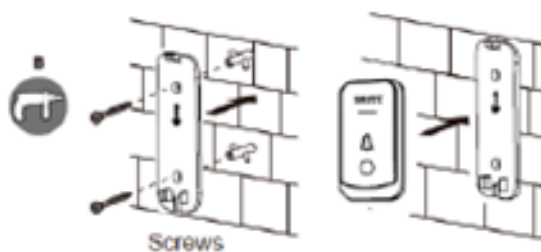

Transmitter unit (Weatherproof IP44)



AC BRITZ®

Complies with
IMDA Standards
DA 102832

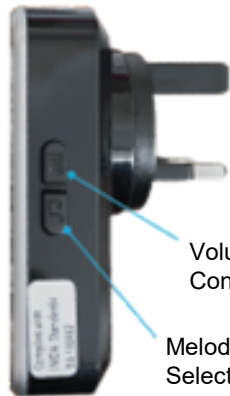

Volume
Control

Melody
Selection

Model: 667AC

Description

- 45 Different Chimes
- Bright LED Flash Light
- Transmitter is IP44
- Anti-Interference System
- 200M Reachable Distance



Battery



UK 3-PIN

Features

- Strong anti-interference and jamming system to prevent false triggering and interference.
- Wireless remote control reaches up to 200m range.
- Kinetic transmitter (IP44) is waterproof and weatherproof.
- LED indicator consumes little power.
- Ideal for homes, offices, factories, hospitals and guest rooms in hotel etc. It can also be used for message notifying, alarms for the patients and elderly people.



Adhesive Tape

Screws

Transmitter unit (Weatherproof IP44)



Pry Open Here

Alkaline Battery 23A12V

DC BRITZ[®]



Model: 024DC

Description

- 3 Different Chimes
- 3x AAA Batteries



*Able to mount on
1Gang Box
**Box not Included



Model: 207DC

Description

- Striking Mechanical Chime
- 4x C Size Batteries
- Include 1 Transmitter
- Stripe Design



Model: 208DC

Description

- Striking Mechanical Chime
- 4x C Size Batteries
- Include 1 Transmitter
- Cube Design

DC BRITZ®



Model: L128AC

Description

- Mechanical striking chime
- Live wire 230V power

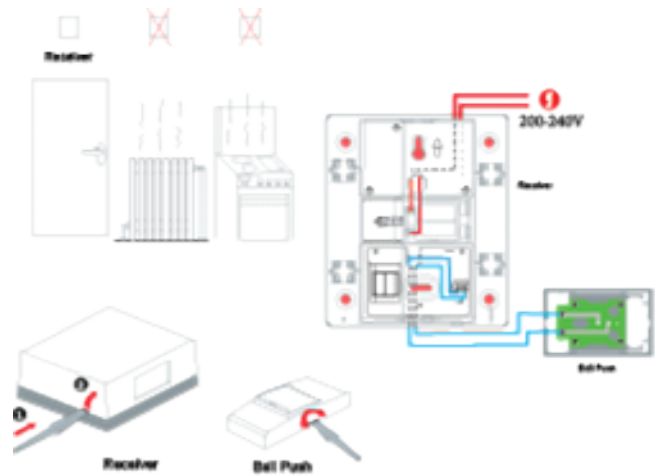

Model: D130DC

Description

- Electronic melody chime
- 3x AA Batteries

DT[®] ENGLAND

Description

- Overheating Reset Button
- Smart Power Indicator Fireproof Material
- Ergonomic Handle Grip



Technical Specification:

- Voltage : 250, 50/60Hz
- Max load : 13 Amp
- Max rate : 1250W or 3000W Fully Unwound
- Cable Rating : 3 Cores x 1.25mm²
- Wire Length : 6M & 10M
- Safety Standard : SS307, BS 1363/A



Model:
DT 9800(1 G6M)



Model:
DT 9800(1G10M)



Model:
DT 9800(2G6M)



Model:
DT 9800(2G10M)

BRITZ[®]



Specification

- Number Of Outlets : 4 x 13A 8S1363
- Plug Type : BS1363A/ A13A
- Thermal Cut Off Protection Reset : Yes
- Cable Type : 1.25mm, 3 Core I H05-VVF 8S6500
- Cable Length : 30Metres / 50Metres
- Max Load Wound : 720w
- Max Load Unwound : 3120W
- Complies To All Relevant British Standard CE : Approved

Features

- Impact resistant outer shell with internal reel
- Flush & recessed power inlet sockets
- Durable steel frame
- Easy wind motion
- Thermal cut off protection
- Reel stopper at the back of reel



Reel Stopper



Thermal cut off protection reset button

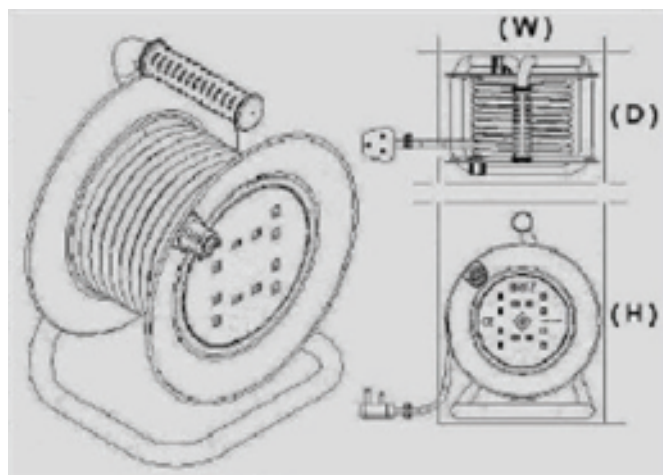

Dimension:

BRITZ 30Meter 270X345x195mm
(W x H x D) - WEIGHT: 6. 10kg

BRITZ 50Meter 270X345x195mm
(W x H x D) - WEIGHT: 4. 10kg

Available 30M & 50M

BRITZ[®]



Fire Retardant Material



100% OFC Copper Cable



Neon Large Indicator With 2 Pin Friendly Safety Shutter

Recommended Connection For:

- Home electronic, audio, video sets
- Office equipments
- Computer, peripherals
- Power hand tools, etc.

Technical Specification:

- Rated Voltage : 240 Volts
- Rated Current : 13 Amperes max
- Power : 3240 Watts max
- Power Indicator : Neon
- PSO Standard : SS145, BS1363
- Plug Used : Fuse Plug, SS145, BS1363
- Fuse Used : 13A, SS167, BS1362
- Cable Rating : 1.25mm², 3 Cores PVC cable



**Available in
2M Only**

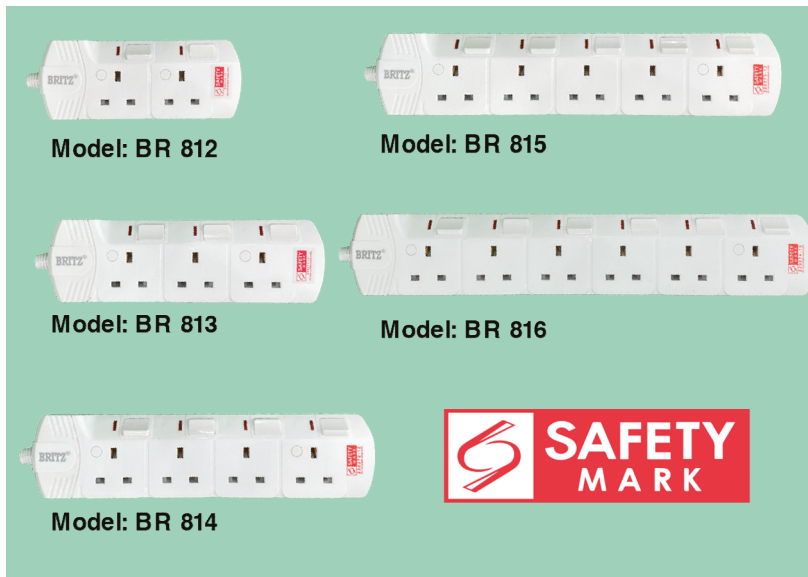

Direct 2-Pin Plug in



Strong moulded cable gland to prevent cable break off

BRITZ[®]



**Fire Retardant
Material**



**100% OFC
Copper Cable**



**Neon Large Indicator
With 2 Pin Friendly
Safety Shutter**

Recommended Connection For:

- Home electronic, audio, video sets
- Office equipments
- Computer, peripherals
- Power hand tools, etc.

Technical Specification:

- Rated Voltage : 240 Volts
- Rated Current : 13 Amperes max
- Power : 3240 Watts max
- Power Indicator : Neon
- PSO Standard : SS145, BS1363
- Plug Used : Fuse Plug, SS145, BS1363
- Fuse Used : 13A, SS167, BS1362
- Cable Rating : 1.25mm², 3 Cores PVC cable



Model: BR 812BK



Model: BR 81 SBK



Model: BR 813BK



Model: BR 816BK



Model: BR 814BK



Available in 2M Only



Direct 2-Pin Plug in



**Strong moulded cable
gland to prevent cable
break off**

BRITZ®



Fire Retardant Material



100% OFC Copper Cable



Neon Large Indicator With 2 Pin Friendly Safety Shutter



SURGE PROTECTION

Recommended Connection For:

- Home electronic, audio, video sets
- Office equipments
- Computer, peripherals
- Power hand tools, etc.

Technical Specification:

- Rated Voltage : 240 Volts
- Rated Current : 13 Amperes max
- Power : 3240 Watts max
- Power Indicator : Neon
- PSO Standard : SS145, BS1363
- Plug Used : Fuse Plug, SS145, BS1363
- Fuse Used : 13A, SS167, BS1362
- Cable Rating : 1.25mm², 3 Cores PVC cable



**Available in
3M & 6M**

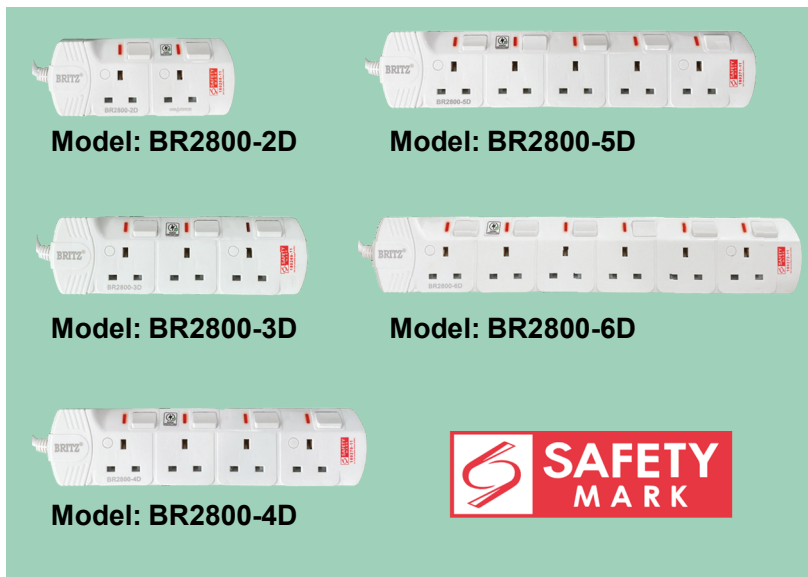

Direct 2-Pin Plug in



Strong moulded cable gland to prevent cable break off

BRITZ®



**Fire Retardant
Material**

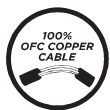

**100% OFC
Copper Cable**



**Neon Large Indicator
With 2 Pin Friendly
Safety Shutter**



**SURGE
PROTECTION**

Recommended Connection For:

- Home electronic, audio, video sets
- Office equipments
- Computer, peripherals
- Power hand tools, etc.



**Approved BS1363
SURGE PROTECTOR
WITH INDICATOR**

Technical Specification:

- Rated Voltage : 240 Volts
- Rated Current : 13 Amperes max
- Power : 3240 Watts max
- Power Indicator : Neon
- PSO Standard : SS145, BS1363
- Plug Used : Fuse Plug, SS145, BS1363
- Fuse Used : 13A, SS167, BS1362
- Cable Rating : 1.25mm², 3 Cores PVC cable



**Available in
3M Only**



Model: BR 812S



Model: BR 815S



Model: BR 813S



Model: BR 816S



Model: BR 814S



Direct 2-Pin Plug in



Strong moulded cable
gland to prevent cable
break off

BRITZ®



Fire Retardant Material

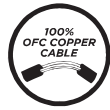

100% OFC Copper Cable



Neon Large Indicator With 2 Pin Friendly Safety Shutter



SURGE PROTECTION

Recommended Connection For:

- Home electronic, audio, video sets
- Office equipments
- Computer, peripherals
- Power hand tools, etc.

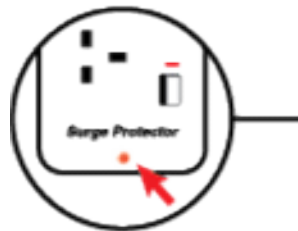

Approved BS1363 SURGE PROTECTOR WITH INDICATOR

Technical Specification:

- Rated Voltage : 240 Volts
- Rated Current : 13 Amperes max
- Power : 3240 Watts max
- Power Indicator : Neon
- PSO Standard : SS145, BS1363
- Plug Used : Fuse Plug, SS145, BS1363
- Fuse Used : 13A, SS167, BS1362
- Cable Rating : 1.25mm², 3 Cores PVC cable

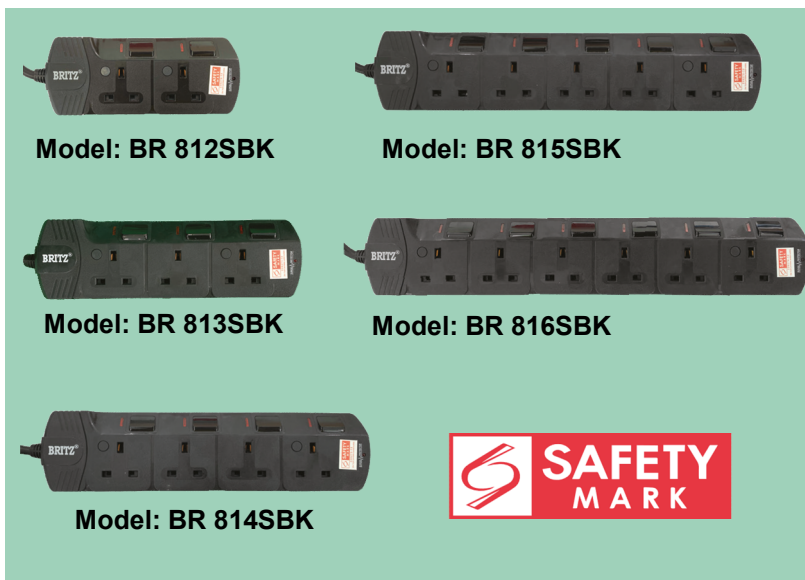

Model: BR 812SBK

Model: BR 815SBK

Model: BR 813SBK

Model: BR 816SBK

Model: BR 814SBK



Available in 3M Only



Direct 2-Pin Plug in

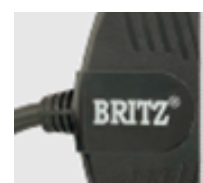

Strong moulded cable gland to prevent cable break off

DT[®] ENGLAND



**Fire Retardant
Material**

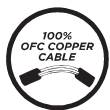

**100% OFC
Copper Cable**



**Coloured Switches
With LED Indicator**



**SURGE
PROTECTION**

Recommended Connection For:

- Home electronic, audio, video sets
- Office equipments
- Computer, peripherals
- Power hand tools, etc.

Technical Specification:

- Rated Voltage : 240 Volts
- Rated Current : 13 Amperes max
- Power : 3240 Watts max
- Power Indicator : Neon
- PSO Standard : SS145, BS1363
- Plug Used : Fuse Plug, SS145, BS1363
- Fuse Used : 13A, SS167, BS1362
- Cable Rating : 1.25mm², 3 Cores PVC cable

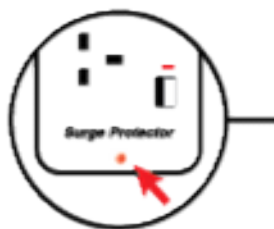

**Approved BS1363
SURGE PROTECTOR
WITH INDICATOR**



Model: DT 862



Model: DT 865



Model: DT 863



Model: DT 866



Model: DT 864



Available in 3M & 6M



Direct 2-Pin Plug in



**Strong moulded cable
gland to prevent cable
break off**

DT[®] ENGLAND

2 USB



Fire Retardant Material

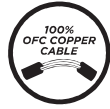

100% OFC Copper Cable



Coloured Switches With LED Indicator



SURGE PROTECTION



Recommended Connection For:

2x USB Charger (2.1A)

- Home electronic, audio, video sets
- Office equipments
- Computer, peripherals
- Power hand tools, etc.



Approved BS1363 SURGE PROTECTOR WITH INDICATOR

Technical Specification:

- Rated Voltage : 240 Volts
- Rated Current : 13 Amperes max
- Power : 3240 Watts max
- Power Indicator : Neon
- PSO Standard : SS145, BS1363
- Plug Used : Fuse Plug, SS145, BS1363
- Fuse Used : 13A, SS167, BS1362
- Cable Rating : 1.25mm², 3 Cores PVC cable

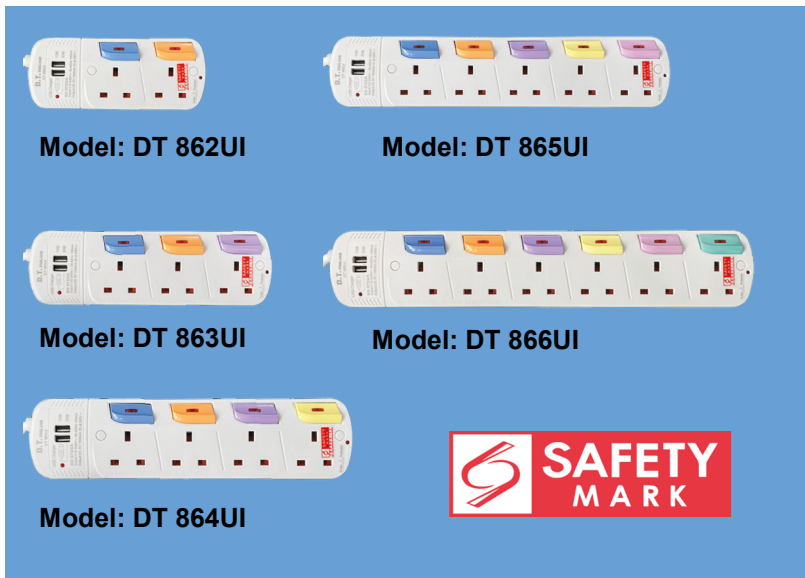

Available in 3M & 6M



Direct 2-Pin Plug in

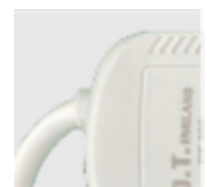

Strong moulded cable gland to prevent cable break off



DT[®] ENGLAND

3 USB



Fire Retardant Material



100% OFC Copper Cable



Neon Large Indicator With 2 Pin Friendly Safety Shutter



SURGE PROTECTION



2x USB & 1 TYPE C Port

Recommended Connection For:

- Home electronic, audio, video sets
- Office equipments
- Computer, peripherals
- Power hand tools, etc.

Technical Specification:

- Rated Voltage : 240 Volts
- Rated Current : 13 Amperes max
- Power : 3240 Watts max
- Power Indicator : Neon
- PSO Standard : SS145, BS1363
- Plug Used : Fuse Plug, SS145, BS1363
- Fuse Used : 13A, SS167, BS1362
- Cable Rating : 1.25mm², 3 Cores PVC cable



Approved BS1363 SURGE PROTECTOR WITH INDICATOR



Available in 3M Only



Model: DT 872CI



Model: DT 875CI



Model: DT 873CI



Model: DT 876CI



Model: DT 874CI



Direct 2-Pin Plug in

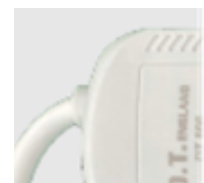

Strong moulded cable gland to prevent cable break off

DT[®] ENGLAND

4 USB



Fire Retardant Material



100% OFC Copper Cable



Neon Large Indicator With 2 Pin Friendly Safety Shutter



4x USB Charger (4.2A)



Approved BS1363 SURGE PROTECTOR WITH INDICATOR

Recommended Connection For:

- Home electronic, audio, video sets
- Office equipments
- Computer, peripherals
- Power hand tools, etc.

Technical Specification:

- Rated Voltage : 240 Volts
- Rated Current : 13 Amperes max
- Power : 3240 Watts max
- Power Indicator : Neon
- PSO Standard : SS145, BS1363
- Plug Used : Fuse Plug, SS145, BS1363
- Fuse Used : 13A, SS167, BS1362
- Cable Rating : 1.25mm², 3 Cores PVC cable

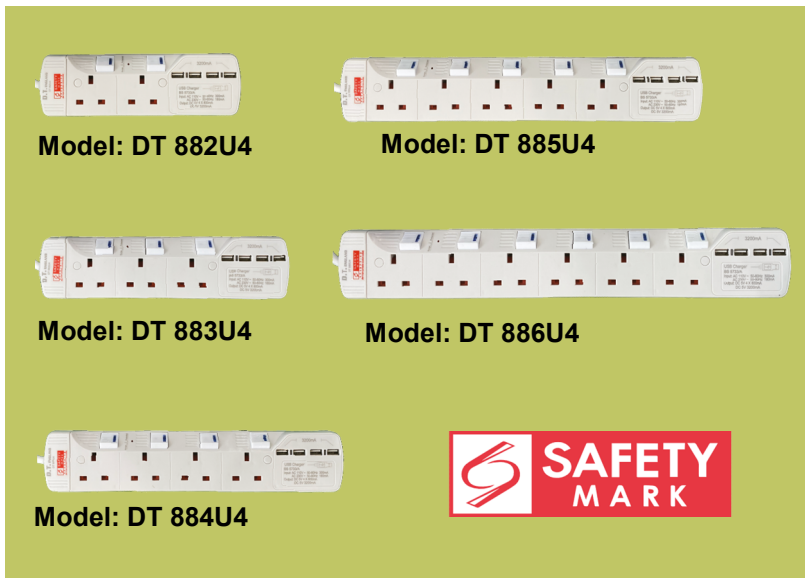

Available in 3M & 6M



Direct 2-Pin Plug in



Strong moulded cable gland to prevent cable break off

DT[®] ENGLAND

4 USB



Fire Retardant Material



100% OFC Copper Cable



Neon Large Indicator With 2 Pin Friendly Safety Shutter



Recommended Connection For:

- Home electronic, audio, video sets
- Office equipments
- Computer, peripherals
- Power hand tools, etc.

- 3x USB & 1 TYPE C Port
- USB Timer Function. Automatically Turn Off After 3 Hour /6 Hour

Technical Specification:

- Rated Voltage : 240 Volts
- Rated Current : 13 Amperes max
- Power : 3240 Watts max
- Power Indicator : Neon
- PSO Standard : SS145, BS1363
- Plug Used : Fuse Plug, SS145, BS1363
- Fuse Used : 13A, SS167, BS1362
- Cable Rating : 1.25mm², 3 Cores PVC cable



Available in 3M Only



Model: DT 712C1



Model: DT 715C1



Model: DT 713C1



Model: DT 716C1



Model: DT 714C1



Direct 2-Pin Plug in



Strong moulded cable gland to prevent cable break off

DT[®] ENGLAND

4 USB



Fire Retardant Material



100% OFC Copper Cable



Neon Large Indicator With 2 Pin Friendly Safety Shutter

Recommended Connection For:

- Home electronic, audio, video sets
- Office equipments
- Computer, peripherals
- Power hand tools, etc.



- **3x USB & 1 TYPE C Port**
- **USB Timer Function. Automatically Turn Off After 3 Hour /6 Hour**

Technical Specification:

- Rated Voltage : 240 Volts
- Rated Current : 13 Amperes max
- Power : 3240 Watts max
- Power Indicator : Neon
- PSO Standard : SS145, BS1363
- Plug Used : Fuse Plug, SS145, BS1363
- Fuse Used : 13A, SS167, BS1362
- Cable Rating : 1.25mm², 3 Cores PVC cable



Available in 3M & 6M



Direct 2-Pin Plug in



Strong moulded cable gland to prevent cable break off

MACRO



**Fire Retardant
Material**



**Universal
Socket Outlet**



**Neon Large Indicator
With 2 Pin Friendly
Safety Shutter**



**SURGE
PROTECTION**

Recommended Connection For:

- Home electronic, audio, video sets
- Office equipments
- Computer, peripherals
- Power hand tools, etc.

Technical Specification:

- Rated Voltage : 240 Volts
- Rated Current : 13 Amperes max
- Power : 3240 Watts max
- Power Indicator : Neon
- PSO Standard : SS145, BS1363
- Plug Used : Fuse Plug, SS145, BS1363
- Fuse Used : 13A, SS167, BS1362
- Cable Rating : 1.25mm², 3 Cores PVC cable

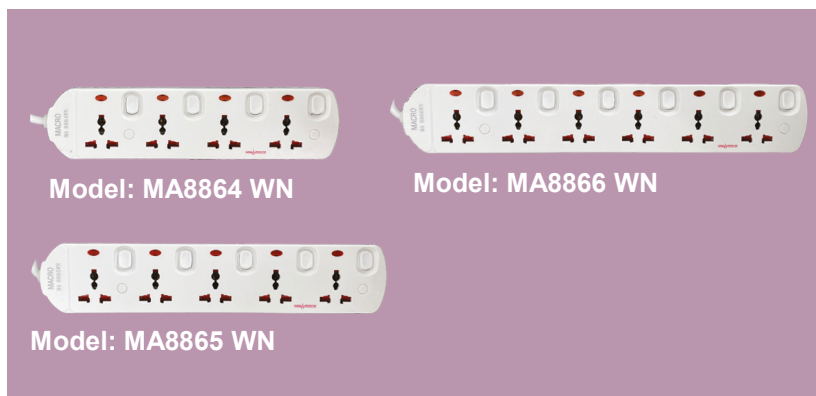

Available in 3M Only



Direct 2-Pin Plug in



Strong moulded cable gland to prevent cable break off

BRITZ®

Model: ST FLOODLIGHT

Description

- Lamp Power : 50W, 100W, 150W, 200W, 400W
- Lamp Body Material : Aluminium
- Cover Material : 5mm High Strength Glasses
- CRI (Ra>)Power Supply : 80
- LED Colour : AC 100V-265V
- LED Light Source : Daylight
- IP Rating : SMD Plato S
- Beam Angle(°) : IP65
- Working Lifetime(HR) : 120° Degree
- Power Factor : 50000 HR
- Prewired 1Meter Rubber Cable : 0.9

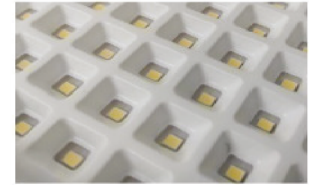

5mm High Strength Glasses
High lumen good quality LED chip

**HEAVYDUTY WEATHERPROOF
OUTDOOR IP65 CLASS
1MAINTENANCE FREE PREWIRED
WITH 1M EXTERNAL CABLE
NEOPRENE CABLE**



Dimension (mm)

Model	H(mm)	L(mm)	W(mm)	D(mm)
AX-FL-S T-50W	216	246	160	46
AX-FL-S T-100W	396	323	216	49
AX-FL-S T-150W	320	357	261	57
AX-FL-S T-200W	372	402	267	57
AX-FL-S T-300W	432	485	355	56
AX-FL-S T-400W	495	545	370	58

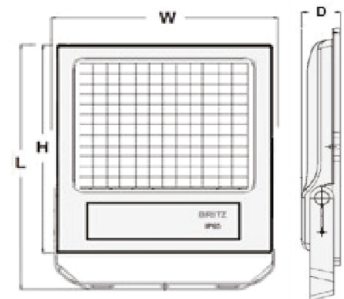

Luminous Intensity Distribution

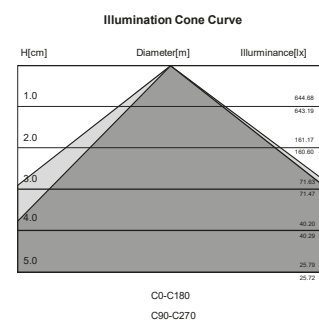
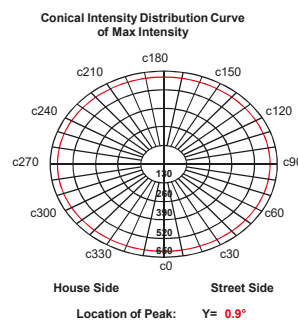
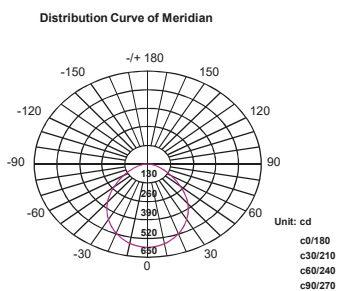

BRITZ®

Model: 6064 FLOODLIGHT

Description

- Lamp Power : 50W, 100W, 200W, 300W, 400W
- Lamp Body Material : Die-cast aluminium, tempered glass
- Input : AC85-265V
- Frequency : 50Hz / 60Hz
- Lumen : 90LM / W
- LED Colour : Daylight
- LED Light Source : COB LED chip
- IP Rating : IP66 (Lamp & Gear compartments)
- Beam Angle(°) : 120° Degree
- Prewired 1Meter Rubber Cable

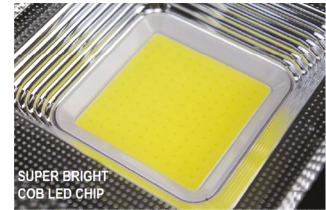

Flicking Free



50,000+ hours



Integrated Circuit

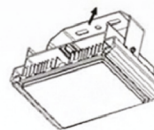

ANGLE FACE DOWN



STRAIGHT FACE DOWN CAN SUBSTITUTE AS HIGH BAY

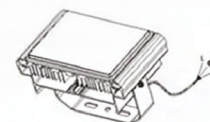

ANGLE FACE UP

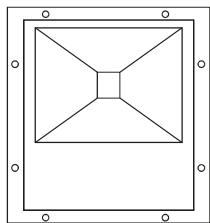

L

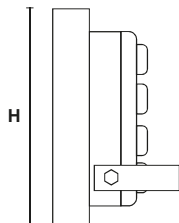

H

W

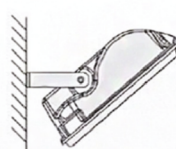

ANGLE WALL MOUNT

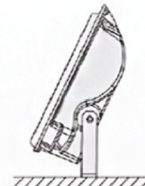

FLOOR MOUNT

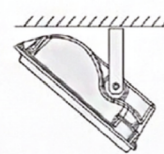

CEILING MOUNT

Dimension (mm)

Model	Description	Colour	H(mm)	L(mm)	W(mm)
BR-LED-6064-50W	50W LED FLOODLIGHT	Black	270	240	68
BR-LED-6064-100W	100W LED FLOODLIGHT	Black	315	285	98
BR-LED-6064-200W	200W LED FLOODLIGHT	Black	376	340	100
BR-LED-6064-300W	300W LED FLOODLIGHT	Black	490	475	107
BR-LED-6064-400W	400W LED FLOODLIGHT	Black	595	475	110

BRITZ®

LED Rechargeable Floodlight Tripod

Description

- Light Source : : 10W, 20W Epistar chip 90LM/W
- Input Voltage : : AC100-240V or DC 12/24V (10W&20W)

- Colour Temperature : : Daylight 6000K~6500K
- IP Rating : : IP65
- AC/DC adapter, 12/24V car plug charger included

Features

- Die-cast aluminium finished with durable epoxy powder coating
- Anti glare high transparency clear tempered glass
- Adjustable height from 94cm to 180cm
- Detachable light pivots 360°
- Tripod collapses for easy storage
- Lamp grid protection



**12-24V
Car Charger**



**AC100-240V
Adaptor Charger**

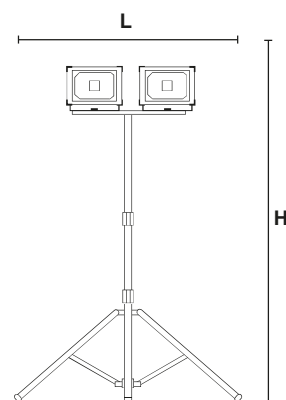
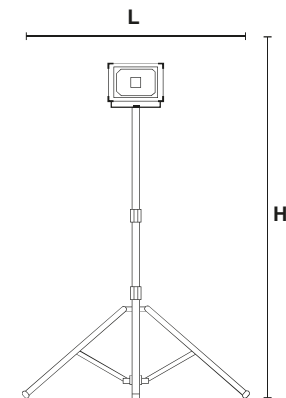

Dimension (mm)

Model	Description	Power Supply	H(mm)	L(mm)	W(mm)
BRITZ LED 1801	1X20W LED TRIPOD	230V / 50Hz	1760	825	178
BRITZ LED 1802	2X20W LED TRIPOD	230V / 50Hz	1760	825	545

BRITZ®

Model: 50W 6064 FLOODLIGHT

Description

- Lamp Power : 50W
- Lamp Body Material : Die-cast aluminium, tempered glass
- Input : AC85-265V
- Frequency : 50Hz / 60Hz
- Lumen : 90LM / W
- LED Colour : Daylight
- LED Light Source : COB LED chip
- IP Rating : IP66 (Lamp & Gear compartments)
- Beam Angle(°) : 120° Degree
- Prewired 1Meter Rubber Cable

PHOTOMETRIC CURVE

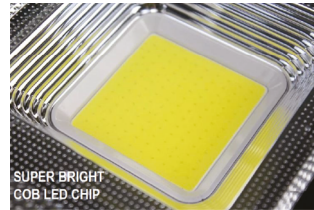
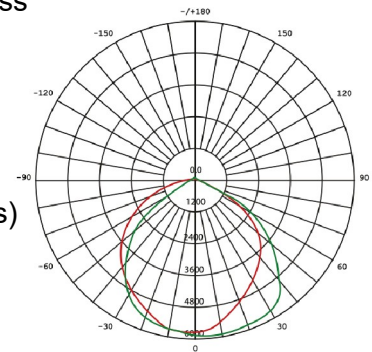

Flicking Free



50,000+ hours



Integrated Circuit

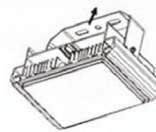
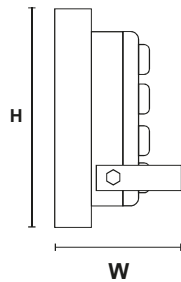
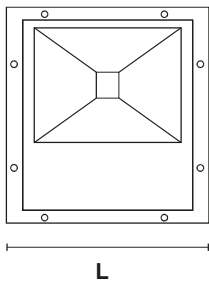

ANGLE FACE DOWN

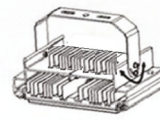

STRAIGHT FACE DOWN
CAN SUBSTITUTE AS HIGH BAY



ANGLE FACE UP

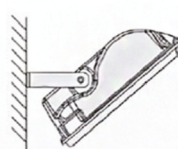

ANGLE WALL MOUNT

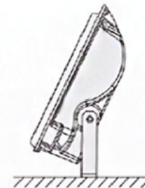

FLOOR MOUNT

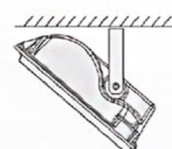

CEILING MOUNT

Dimension (mm)

Model	Description	Colour	H(mm)	L(mm)	W(mm)
BR-LED-6064-50W	50W LED FLOODLIGHT	Black	270	240	68

BRITZ[®]

Model: 100W 6064 FLOODLIGHT

Description

- Lamp Power : 100W
- Lamp Body Material : Die-cast aluminium, tempered glass
- Input : AC85-265V
- Frequency : 50Hz / 60Hz
- Lumen : 90LM / W
- LED Colour : Daylight
- LED Light Source : COB LED chip
- IP Rating : IP66 (Lamp & Gear compartments)
- Beam Angle(°) : 120° Degree
- Prewired 1Meter Rubber Cable

PHOTOMETRIC CURVE

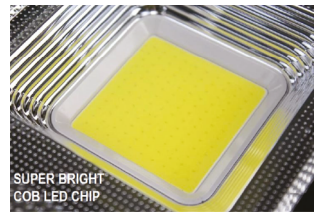
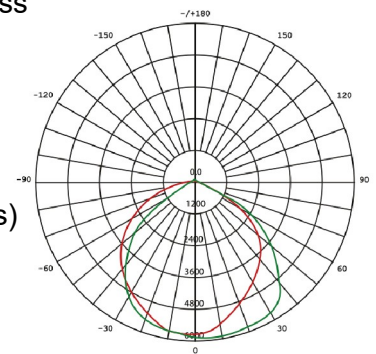

Flicking Free



50,000+ hours



Integrated Circuit

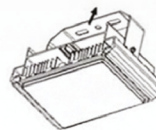
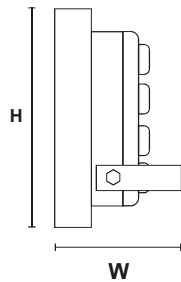
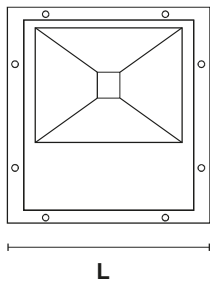

ANGLE FACE DOWN



STRAIGHT FACE DOWN
CAN SUBSTITUTE AS HIGH BAY

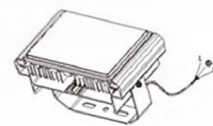

ANGLE FACE UP

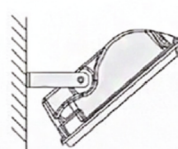

ANGLE WALL MOUNT

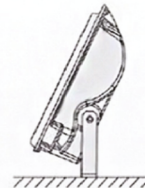

FLOOR MOUNT

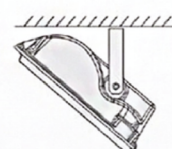

CEILING MOUNT

Dimension (mm)

Model	Description	Colour	H(mm)	L(mm)	W(mm)
BR-LED-6064-100W	100W LED FLOODLIGHT	Black	315	285	98

BRITZ®

Model: 300W 6064 FLOODLIGHT

Description

- Lamp Power : 300W
- Lamp Body Material : Die-cast aluminium, tempered glass
- Input : AC85-265V
- Frequency : 50Hz / 60Hz
- Lumen : 90LM / W
- LED Colour : Daylight
- LED Light Source : COB LED chip
- IP Rating : IP66 (Lamp & Gear compartments)
- Beam Angle(°) : 120° Degree
- Prewired 1Meter Rubber Cable

PHOTOMETRIC CURVE

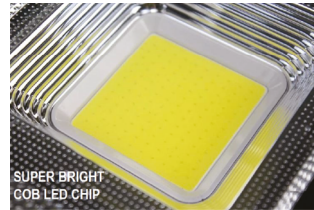
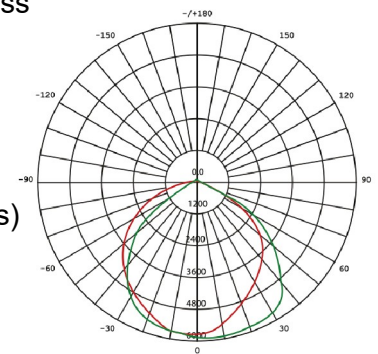

Flicking Free



50,000+ hours



Integrated Circuit

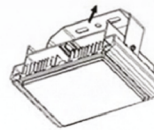
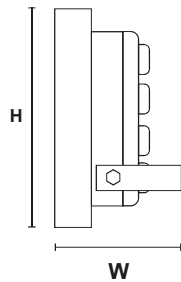
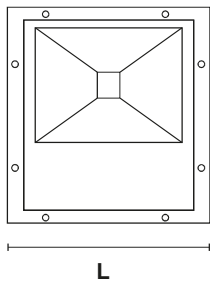

ANGLE FACE DOWN

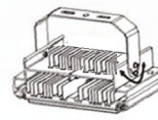

STRAIGHT FACE DOWN
CAN SUBSTITUTE AS HIGH BAY

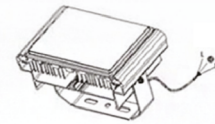

ANGLE FACE UP

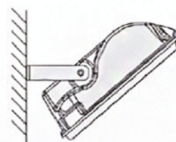

ANGLE WALL MOUNT

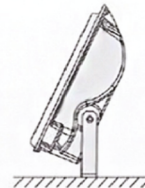

FLOOR MOUNT

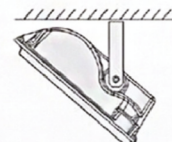

CEILING MOUNT

Dimension (mm)

Model	Description	Colour	H(mm)	L(mm)	W(mm)
BR-LED-6064-300W	300W LED FLOODLIGHT	Black	490	475	107

BRITZ®

Model: 400W 6064 FLOODLIGHT

Description

- Lamp Power : 400W
- Lamp Body Material : Die-cast aluminium, tempered glass
- Input : AC85-265V
- Frequency : 50Hz / 60Hz
- Lumen : 90LM / W
- LED Colour : Daylight
- LED Light Source : COB LED chip
- IP Rating : IP66 (Lamp & Gear compartments)
- Beam Angle(°) : 120° Degree
- Prewired 1Meter Rubber Cable

PHOTOMETRIC CURVE

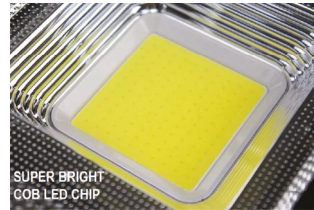
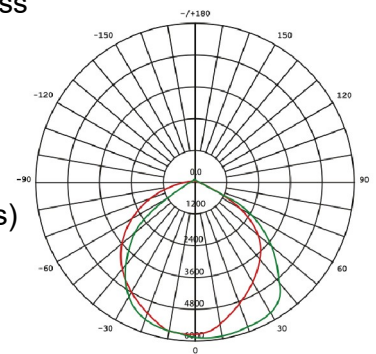

Flicking Free



50,000+ hours



Integrated Circuit

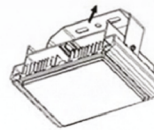
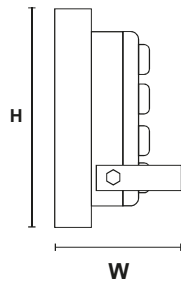
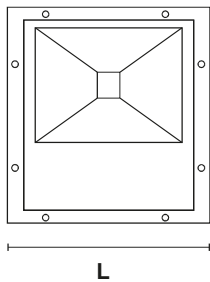

ANGLE FACE DOWN

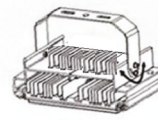

STRAIGHT FACE DOWN
CAN SUBSTITUTE AS HIGH BAY



ANGLE FACE UP

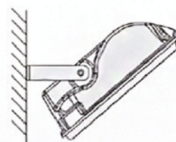

ANGLE WALL MOUNT

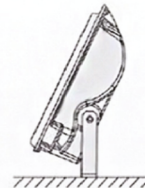

FLOOR MOUNT

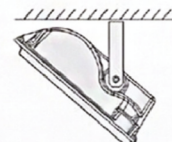

CEILING MOUNT

Dimension (mm)

Model	Description	Colour	H(mm)	L(mm)	W(mm)
BR-LED-6064-400W	400W LED FLOODLIGHT	Black	595	475	110

BRITZ®

100W LED UFO High Bay Light

Our rugged LED high-bay light features a 30,000-hour long lifespan, an IP65 protection, and the highest power efficiency (130 lm/w) high Lumen output energy saving. The product is ideal for general, task, and accent lighting, especially those with high-ceiling (5m and above). BRITZ LED strives to offer the best quality and cost performance LED lighting products available on the market

Description

- Input voltage : AC 100-277V-50/60Hz
- Power : 100W
- Light effect : 5%
- Lumens flux : 120-140 lm/W
- Light emitting diode : 13000lm
- Color temperature : 300pcs* SMD2835
- Color rendering index : 6000k/4000k/3000k
- Color tolerance adjustment : Ra>70
- Power factor : ≤ 10SDCM
- THD : ≥ 0.95: ≤ 15%
- Efficiency : ≥ 88%
- Working temperature : -25°C- +40°C
- Service life : 30000H
- IK protection level : IK08
- IP Protection : IP65
- Level Insulation grade : Class I
- Surge protection : 4KV

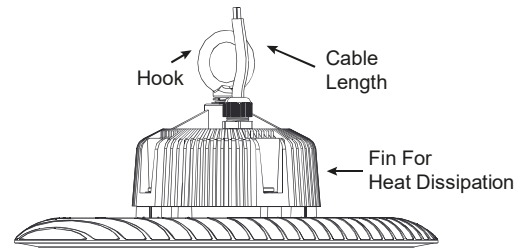

Good Quality Acrylic Reflector Conical Droplet Lens For Better Light Output

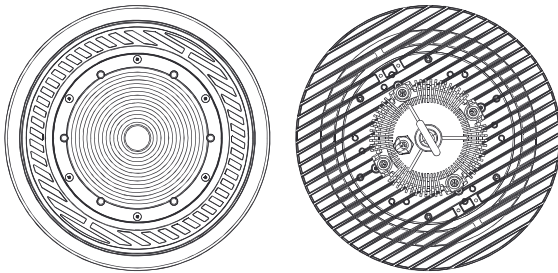

Dimension (mm)

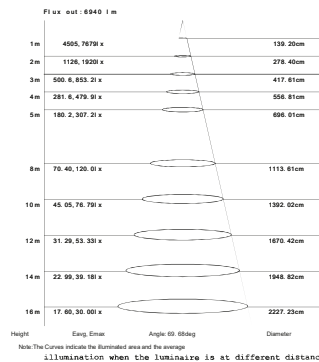
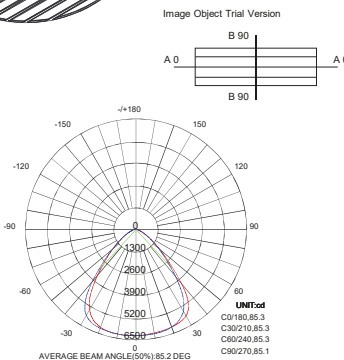
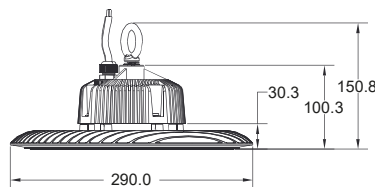

BRITZ®

150W LED UFO High Bay Light

Our rugged LED high-bay light features a 30,000-hour long lifespan, an IP65 protection, and the highest power efficiency (130 lm/w) high Lumen output energy saving. The product is ideal for general, task, and accent lighting, especially those with high-ceiling (5m and above). BRITZ LED strives to offer the best quality and cost performance LED lighting products available on the market

Description

- Input voltage : AC 100-277V-50/60Hz
- Power : 150W +- 5%
- Light effect : 120-140 lm/W
- Lumens flux : 19500lm
- Light emitting diode : 450pcs* SMD2835
- Colour temperature : 6000k/4000k/3000k
- Colour rendering index : Ra>70
- Colour tolerance adjustment : ≤ 10SDCM
- Power factor : ≥ 0.95
- THD : ≤ 15%
- Efficiency : ≥ 88%
- Working temperature : -25°C- +40°C
- Service life : 30000H
- IK protection level : IK08
- IP Protection : IP65
- Level Insulation grade : Class I
- Surge protection : 4KV

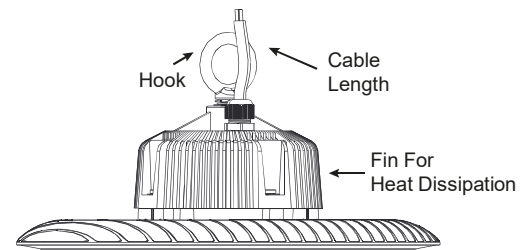

Good Quality Acrylic Reflector Conical Droplet Lens For Better Light Output

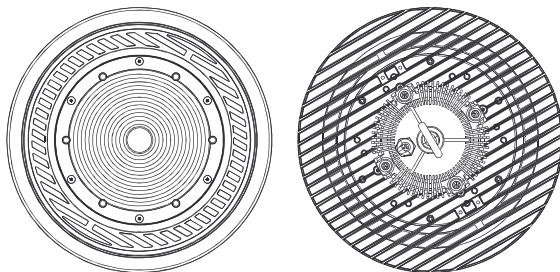

Dimension (mm)

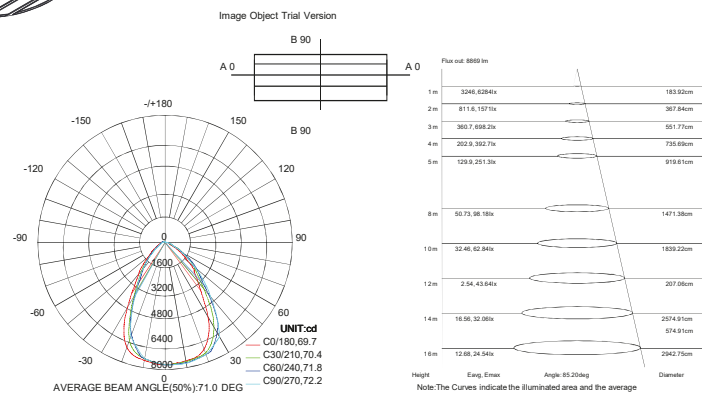
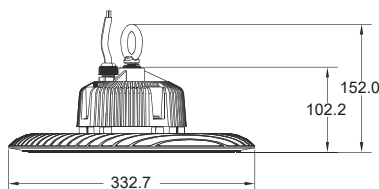

VOX

Model:
Weatherproof 4 Way Portable
DB 40A Single Phase

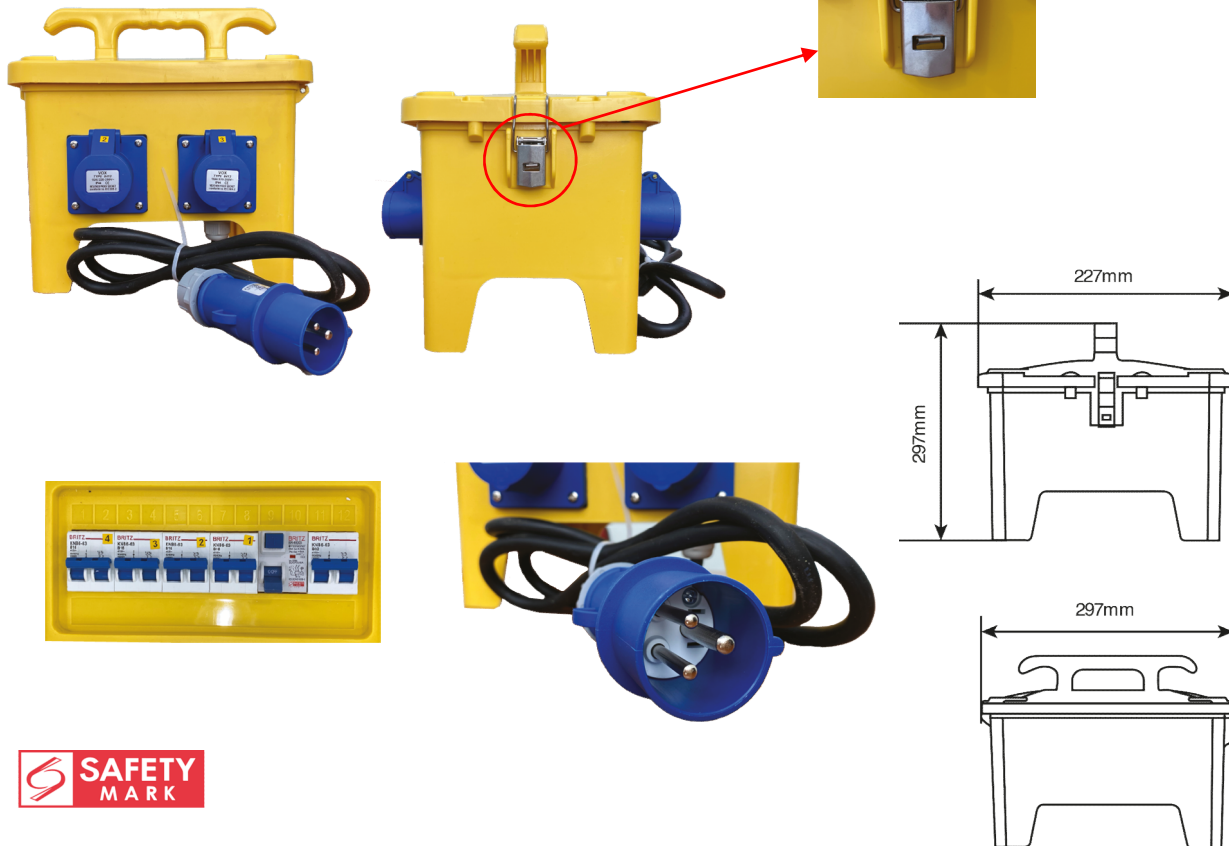

Material	Flame Retardant
Input	1pcs CEE Plug IP44 (IP67 Optional) 16A 2P+E Plug 230V~ (110v Yellow Socket outlet Optional) 3G2.5sq mm Neoprene cable (1.7meters)
Output	4 pcs 16A 2P+E Socket outlet 230V~ IP44 (IP67 Optional) (110v Yellow Socket outlet Optional)
Protection Fuse	1 pcs 32A 2P MCB 240V~ (INCOMING) 1 pcs 40A 2P Approved 6KA ELCB 0.03mA 240V~ 4 pcs 16A 2P MCB 240V~
Protection Degree	IP44 (IP67 Optional)
Compliance	EC/EN60439-1 & IEC/EN60439-4

VOX

Model:
Weatherproof 3 Way Portable DB 40A Single Phase



ELCB APPROVED
 WITH SAFETY MARK

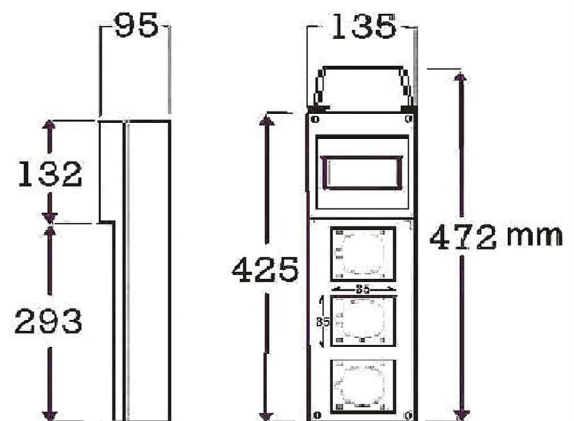

Input	Protection	Output
CEE PLUG 16A 2P+E 230V 3G2.5SG mm cable 1.8m	1RCD 40A 2P 0.03A 230V~ 3MCB 16A 1P 230V~	3 CEE Socket 16A 2P+E 230V~

Model: OKIES-22W / 32W / 40W

- Daylight (6500K)
- Extra Bright
- Low Heat Dissipation
- Long Lifespan
- Tri-Phosphorus Coating (Bright & Lasting)



ENERGY EFFICIENCY

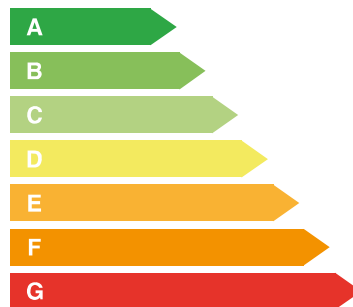

A



EXTRA
BRIGHT

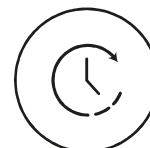

LONG
LASTING

BRITZ®

Description

- No extra external AC-DC driver needed; Low-heat radiation, high-end solution for ceiling lights.
- Special circuit design can resist lightning strikes, and is safe to use during thunderstorms.
- LED light module has better performance in heat dissipation, which allows delivers longer life than other LED module.
- Super bright and low-power dissipation, at least 90% energy saving.



19CM

Model: BR-CL01
(18W/DL)



23CM

Model: BR-CLO2
(26W/DL)



27CM

Model: BR-CLOS
(36W/TRI)



32CM

Model: BR-CLOS
(GOW/TRI)



27CM

Model: BR-CLOS
(36W/TRI)



32CM

Model: BR-CLOS
(GOW/TRI)

Features

- Energy Saving
- 360 Degrees Beam Angle High Brightness(100Lm/W)
- Extra Thick Magnet, Strong Absorption, Do Not Obstruct Wire
- Anti Flicker & True Colour
- Easy To Install, Wide Application

ENERGY EFFICIENCY



EXTRA BRIGHT



THICK MAGNET

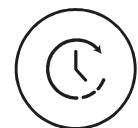

LONG LASTING



BRITZ®

Model: EX-26



- Light source : 10w LED
- Nominal Efficacy : 500 Lumen
- Colour Temperature: 6500K
- IP Rating : IP44
- LED Chip : COB Super Bright Chip
- Input Voltage : SV 1A
- Battery Type : Lithium Battery (4000mA)
- Rechargeable Time : 6 hours Charging Time
- Run Time : 8 hours Working Time
- Light Output : High-Low-Strobe
- Charging : (Indicator Only Appears When Charging)

Green Fully Charged | Red Battery Low
 *** Charge Before Use



Charging Cable



Blister Packing



Strong Hook



Screw Hanging



Strong Holder



Strong Magnetic

Dimension

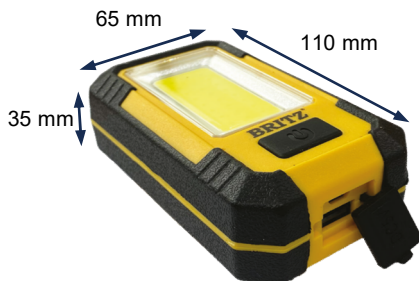

Usage



Equipment Maintenance



Construction Work



Backpacking



Fishing



Camping



Barbecue



Cycle Charge



Dirtproof Sandproof



Shock Proof



Energy Saving



Power Bank

BRITZ®



Model: BR-NL101 Automatic Darkness Sensor

- Power : 0.5WMAX
- Voltage : 220V- 240V
- Brightness : 3 Stage Dimmable
- Colour Temperature : 2700k Warm White
- Sensor : Dusk To Dawn Sensor
- Lumen : 10lm
- Dimensions : 51 x 45 x 80mm

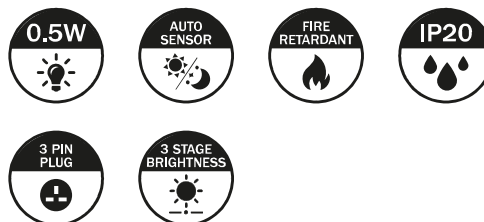

Model: BR-NL 102M Automatic Motion Sensor

- Power : 0.5WMAX
- Voltage : 220V - 240V
- Brightness : 5 Stage Dimmable
- Mode : 3 Modes
: (Auto, Constant On, Off)
- Colour Temperature : 2700k Warm White
- Sensor : Motion Sensor
- Sensor Delay Time : 60 Seconds
- Sensor Angle : 120° :20lm
- Lumen : 70 x 52 x 92mm
- Dimensions

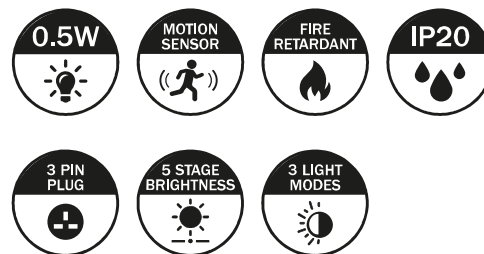

ON Constantly on

OFF Off the light directly

AUTO Auto on when motion is sensed and off after 60 seconds of inactivity

BRITZ®

24W & 30W LED T8 DOUBLE SIDED TUBE

The BRITZ LED T8 Double-Sided Tube offers powerful illumination with energy efficiency. Available in 24W and 30W, these tubes provide high lumens for brilliant, evenly distributed light. Featuring modern LED technology, they are both energy-saving and environmentally friendly, contributing to long-term cost savings and sustainability. With 2 NEA-approved energy label ticks, these tubes adhere to stringent energy performance standards. Easy to install and compatible with existing T8 fixtures, they are a versatile choice for upgrading lighting systems in offices, retail spaces, and homes—delivering high-performance lighting, energy savings, and environmental responsibility.

Description

- Input Voltage : AC 180-265V 50/60Hz
- Power : 24W & 30W
- Light Effect : 115 lm/W
- Lumens Flux 24W : 2760 Lm
- Lumens Flux 30W : 3450Lm
- Energy Efficiency : 2 Energy Label Tick
- Colour Temperature : 6500k
- Colour Rendering Index : Ra>80
- Efficiency : 50000Hrs
- Dimmable : No
- Diameter : 28mm
- Length : 1200mm
- Direct Replace T8 Fluorescent : Yes

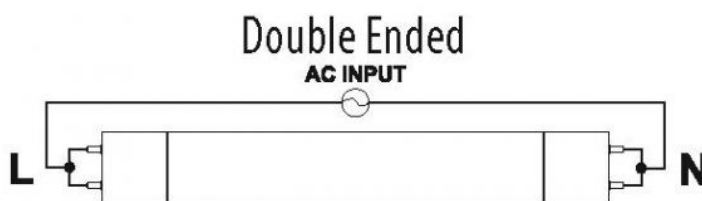

Applications



Carpark Lighting



Retail Lighting



Weatherproof
Lighting



MASTERPLUG

Safety RCD
Adaptor



Safety RCD
Plug



HEAVY DUTY
15 AMP PLUG



FUSED 13AMP





MASTERPLUG

**Permaplug 1
Gang 13A**

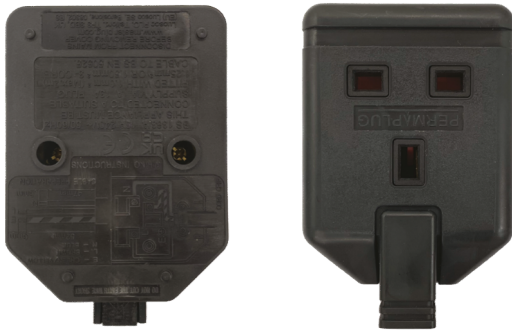

**Permaplug 2
Gang 13A**



Permaplug 4 Gang 13A





MASTERPLUG

Model: CMU10134SL

Description

- Easy wind handle and rear grip
- Ergonomically designed
- Integrated power switch with LED light, Thermal Cut Out
- Connected Equipment Warranty
- 13A Fused
- Switch + LED



Model: HMU15134SL

Description

- The four-socket extension lead has an integrated power switch with LED indicator, allowing more control over devices.
- It also has a thermal cut out which activates due to temperature rises caused by a power surge or overload, giving you peace of mind by minimising the risk of an electrical fire.
- Fixing points in the base allow the cable reel to be mounted for storage or while in use, for further versatility.

Specification

- 4x 13A UK shutter sockets with UK plug
- 240 V
- Power on/off switch
- Power LED indicator
- Safety Thermal Cutoff
- 15m extension lead
- Easy wind handle
- Standards: BS EN 61242. ASTA Approved
- Maximum Load: 720W/240V -Fully Wound 3120W/240V - Fully Unwound





MASTERPLUG

MASTERPLUG SAFETY IN-LINE RCD (ELCB)

Description

Non-latching inline RCD adapter provides added protection against electrocution. The double pole switching both live and neutral when contacts trip. This inline RCD plug will continuously monitor the power supply to an electrical appliance and will cut the power within 40 milliseconds if an earth current fault is detected. The adapter has a current rating of 13A and voltage rating of 240V ac. It has IP65 rating protection for added safety.

Plug to cable in



Cable out to equipment

Features and Benefits

- The four-socket extension lead has an integrated power switch with LED indicator, allowing more control over devices.
- It also has a thermal cut out which activates due to temperature rises caused by a power surge or overload, giving you peace of mind by minimising the risk of an electrical fire.
- Fixing points in the base allow the cable reel to be mounted for storage or while in use, for further versatility.

Specification

- Current Rating 13A
- Inline Yes
- IP Rating IP65
- Pole Format 2
- Tripping Current 30mA 40ms
- Tripping Time Non-Latching
- Type 240V ac
- Voltage Rating 3120W
- Maximum Load BS7071:1992
- Standards Met

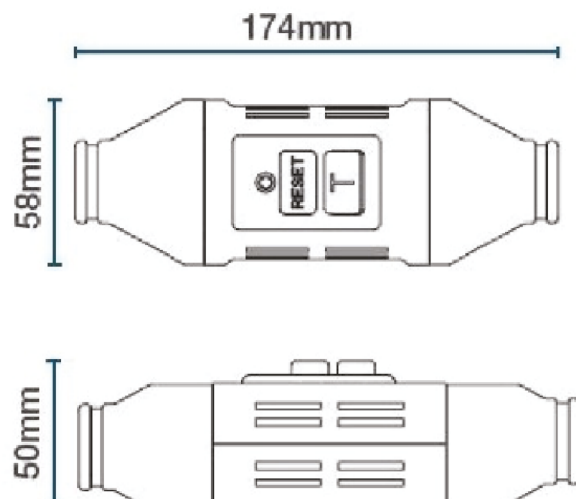



BRITISH GENERAL

British General 2 Gang Moulded Neo Slimline 13A Switched Double Socket with USB Charger

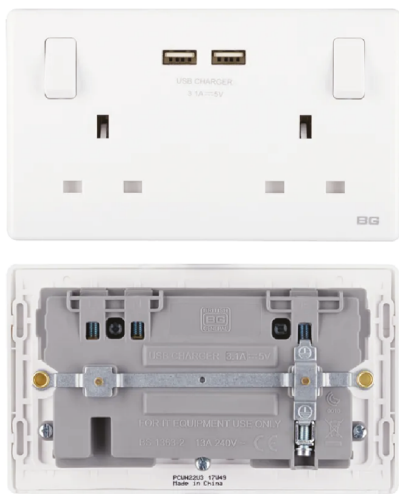

British General 1 Gang Moulded Neo Slimline 13A Switched Double Socket with USB Charger

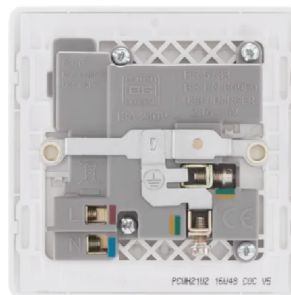

VOX



WHITE VOX
3X40/0076 VOX
3X70/0076



BLACK
VOX 3X40/0076
VOX 3X70/0076
VOX 3X110/0076



GREY
VOX 3X40/0076
VOX 3X70/0076
VOX 3X110/0076

BRITZ[®]



MACRO 2X16 076 WHITE PVC/PVC
BRITZ 2X16 076 BLACK PVC/PVC
BRITZ 2X16 076 GREY PVC/PVC



BRITZ 2X23 076 WHITE PVC/PVC
BRITZ 2X23 076 BLACK PVC/PVC
BRITZ 2X40 076 WHITE PVC/PVC



BRITZ 2X23 015 TWISTED
BRITZ 2X23 076 TWISTED



MACRO 2X23 076 BIR FLAT
MACRO 2X40 076 BIR FLAT



BRITZ 2X40 076 TWISTED

BRITZ[®]



BLACK Neoprene 3 core 1.5mm



BLACK Neoprene 3 core 2.5mm

BRITZ®



Features

- Full plastic louver fan
- PP plastic and frame
- 100% copper motor stable and silence
- Easy to install and clean

Specification

Model	Specification (mm)	Voltage/Frequency (V/Hz}	Watt (W)	Speed (RPM}	Air delivery (m3/b)	Watt (W)
BR-EF6	150	220-240V 50HZ	23	1700 - 2100	4.3	23
BR-EF8	200	220-240V 50HZ	28	1300 - 1500	7.0	28
BR-EF10	250	220-240V 50HZ	36	1700 - 2100	4.3	36
BR-EF12	300	220-240V 50HZ	48	1300 - 1500	7.0	48

Dimension (mm)

Model	A dia.	B sq.	C	D	E
BR-EF6	150	240	190	95	43
BR-EF8	200	295	245	95	43
BR-EF10	250	340	295	95	43
BR-EF12	300	398	340	95	43

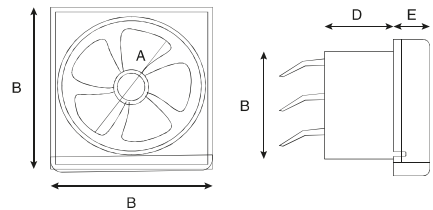

Installation Instruction

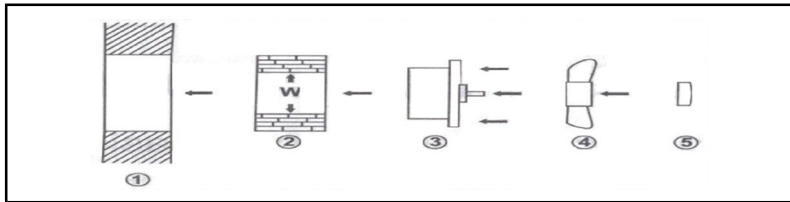

Wiring Diagram

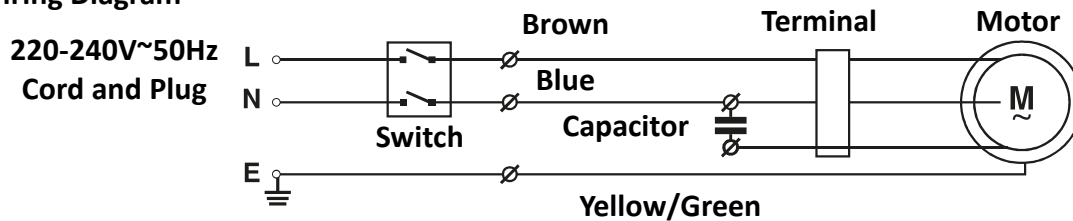

BRITZ[®]



Features

- Exhaust type
- Pull String Immediate Activation
- 100% Pure Copper Motor Guaranteed
- Low Noise Energy Saving
- Easy detachable design for easy cleaning

Specification

Model	Specification (mm)	Voltage/Frequency (V/Hz}	Rated Power (W)	Air delivery (m3/min}	Speed (RPM}
BR-REF6	150	220-240V 50HZ	14	4.3	1700 - 2100
BR-REFS	200	220-240V 50HZ	18	7.0	1300 - 1500

Dimension (mm)

Model	A dia.	B sq.	C	D	E
BR-REF6	208	177	44	41	89
BR-REFS	272	238	50	55	126

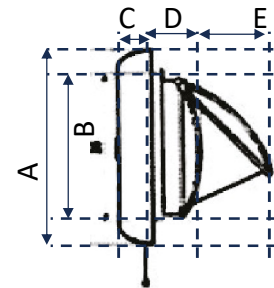

Wiring Diagram

220-240V~50Hz
Cord and Plug

